



Performance Installation Guide

MDSP

MDSP8/4A



GET IT ON
Google Play



Download on the
App Store



Dear Customer,

We sincerely thank you for selecting the Morel MDSP amplifier to power your car audio system. Developed with the same passion and innovative philosophy that drives all of Morel's product development, the MDSP amplifiers deliver high-fidelity performance with dynamic, clean, and uncolored power—designed to bring out the full sonic potential of your speakers. With built-in DSP (Digital Signal Processing), these amplifiers offer advanced tuning capabilities and system control, making them an ideal solution for those seeking audiophile-grade sound in even the most complex installations.

Because the MDSP is a DSP-enabled amplifier, proper setup and integration involve many important factors. Designing, configuring, and tuning a system with DSP can be a detailed process and may feel overwhelming to those unfamiliar with this level of audio control. For that reason, we strongly recommend professional installation by an authorized Morel retailer or qualified technician to ensure the best performance, long-term reliability, and a seamless listening experience.

Before installation, please review this manual carefully to ensure safe and effective operation of your MDSP amplifier. If you need assistance with installation, your local authorized Morel retailer is ready to help. You can also reach our support team at:

info@morelhifi.com

info@morelamerica.com

Experience the road like never before with powerful, precision-tuned sound from your MDSP amplifiers.

Serial Number

Please take the time to enter the serial number in the space provided below. The serial number can be found on the bottom panel of the amplifier and on the amplifier packaging. This is required in the event that your amplifier requires warranty service and may be helpful in recovering your amplifier in case of a theft. Be sure to store you this manual in a safe location.

SERIAL NUMBER: _____

Box Contents

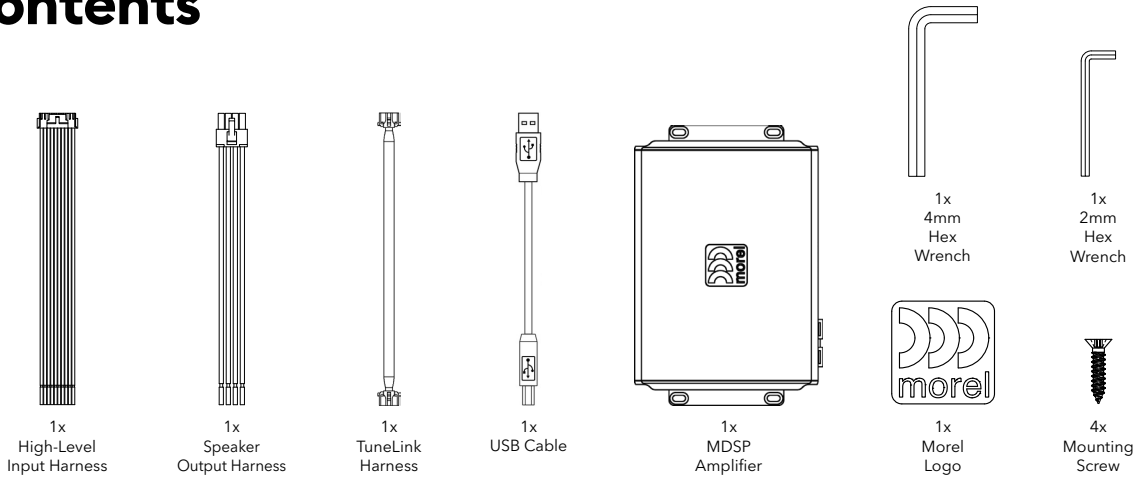

Available Accessories

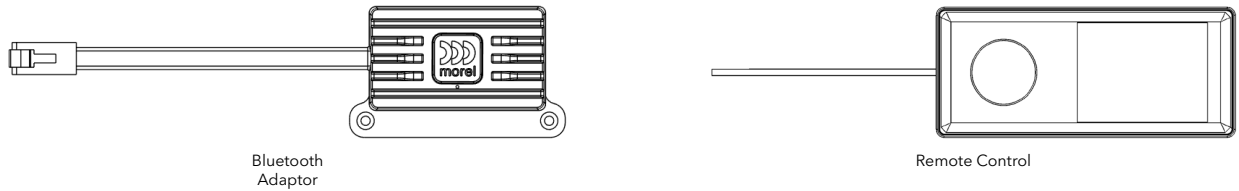

Dimensions

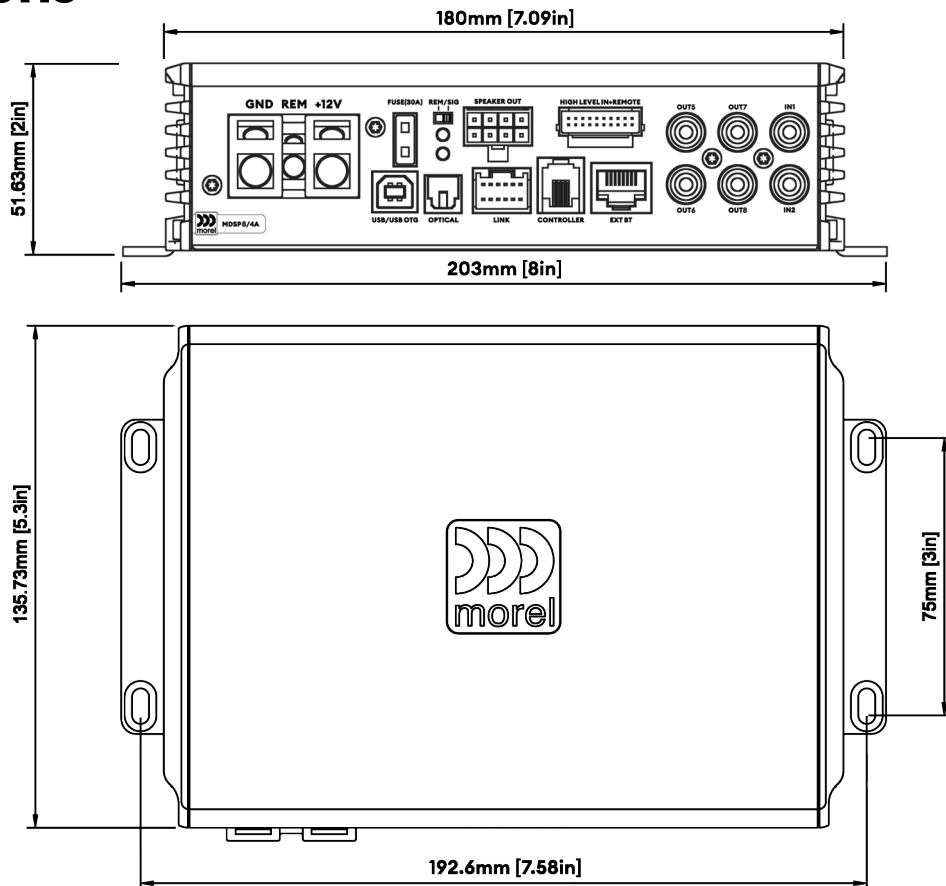

Practice Safe Sound

Studies have shown that continuous exposure to high sound pressure levels from high power audio systems can lead to permanent hearing loss. Additionally, high volume levels can obscure noises from outside your vehicle such as emergency vehicles and horns. As a valued Morel customer, we urge you to use common sense and practice restraint in the operation of this product.

Precaution

The MDSP amplifiers are designed to work with a 12V DC electrical system with negative to ground. Use of this product in vehicles with positive ground and/or voltages other than 12V may result in damage to the product and/or vehicle and will void the warranty.



PLEASE MAKE SURE TO CAREFULLY READ AND UNDERSTAND ALL INSTRUCTIONS PRIOR TO INSTALLATION

Mounting the Amplifier

Choose a location for the amplifier with ample ventilation for optimum cooling performance. Be sure the amplifier is mounted with at least 2-inches (50mm) of clearance around the chassis, and never fully enclose the amplifier in a confined space without active ventilation. It is strongly discouraged to mount the amplifier upside down as this will limit the heatsink's ability to remove heat from the circuitry. Also avoid mounting in areas of direct sunlight and in areas of high vibration, such as a subwoofer enclosure.

Proper mounting consists of the chassis being mounted with the base of the amplifier parallel with the floor or perpendicular to the floor with the fins of the heatsink facing upward for effective cooling.

Your amplifier should always be installed in a location that will remain free of moisture and dirt, and in a manner that does not interfere with any of the electronics or safety gear of the vehicle.

For safety purposes, be sure to take the time to properly mount the amplifier using suitable mounting hardware so the amplifier does not come loose in the event of a collision or unforeseen circumstance.

Protection

Please note that there are no chassis mounted fuses on the MDSP amplifiers. Instead our design uses a microprocessor controlled protection circuit which enables the amplifier to optimize the current flow coming into the power supply. This design lowers loss within the circuitry, increase the power output and improves the sound dynamics of the amplifier for the best listening experience. However, for the safety of you and your vehicle, please follow instructions for installing an inline fuse with your amplifier.

Planning and Installation

For best results, determine the best configuration of your new amplifier and plan the wiring routes to ease installation and optimize performance.

- **IMPORTANT!** Disconnect the vehicle's primary ground terminal from the battery post prior to commencing the installation.
- Make sure the mounting location you chose for the amplifier does not interfere with any functions of the vehicle mechanics and/or electronic devices. Also, be aware of the locations of the gas tank, wiring harnesses, fuel and brake lines, and other vital components of the vehicle prior to drilling any holes in the vehicle's chassis.
- Select high quality signal cables and proper wire. It is highly recommended to use 100% OFC (oxygen free copper) power and speaker wire of proper size for best performance and longevity of the product.
- Do not run power or audio cables on the exterior of the vehicle, including underneath, as this can result in severe damage to the vehicle and person.
- Avoid running power and audio cables next to sensitive electronics within the vehicle, and be sure to route the signal cables away from the power cables.
- Always use rubber grommets when running wire through metal walls or barriers, and use loom to protect the cable from sharp edges or areas of high heat.
- Power amplifiers place an increased load on the electrical charging system. Generally, factory charge systems in good condition should be able to withstand the extra load of an MPS amplifier without a problem. However, multiple amplifier systems can draw excess current and create a serious strain on the electrical system. It is best to consult your audio specialist for advise on whether or not it is necessary to upgrade your electrical system to meet the demands of the audio system.
- Place an insulated in-line fuse holder of the appropriate current capacity within 16 inches (40cm) of the battery positive (+) terminal. Connect to this to the power cable connecting the positive terminal of the amplifier. This fuse is designed to protect the vehicle in the event of a short. Only install the fuse once the power cable has been secured to the amplifier.
- Locate a solid metal area as close to the amplifier as possible to connect the ground wire terminal. Use the same gauge wire for ground as for the power wire. The length of the ground wire should not exceed 36 inches (90cm) from the amplifier. To ensure a solid connection, remove surface paint at the ground point prior to securing the connector in place.

Features

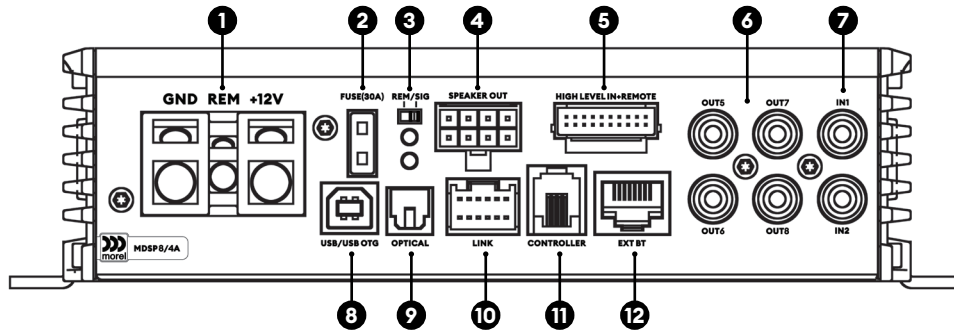

1. Power Connector

Provides power input and remote turn-on signal to the amplifier.

GND (Negative Power Input): Connects to the vehicle chassis or battery negative terminal.

REM (Remote Turn-On, Center): Receives 12V signal to turn the amplifier on.

+12V (Positive Power Input): Connect to battery positive through a fused power wire.

2. Fusing

Three 30-amp fuses provide overcurrent protection for the amplifier's internal circuits.

3. Remote In / Signal Sense Selector Switch

Allows selection between two amplifier turn-on modes:

Remote In: Uses a +12V trigger from the head unit, control source, or switched accessory.

Signal Sense: Turns the amplifier on when a high-level signal is detected on H1+/H1-.

Protection Indicator

Illuminates when the amplifier enters protection mode (e.g., thermal, short circuit, low voltage).

Power Indicator

Blue LED lights up when the amplifier is powered on and operating normally.

4. SPEAKER OUT Connector (Harness)

4-channel speaker output through a dedicated harness; each channel provides 80 watts RMS. Designed for simplified installation and clean integration.

SPK1+	SPK2+	SPK3+	SPK4+
SPK1-	SPK2-	SPK3-	SPK4-

5. HIGH LEVEL IN/REMOTE Connector

Accepts high-level signal input from factory head units and supports signal-sensing turn-on.

Channels 1-6: Supports up to 16 volts RMS input.

Channels 7-8: Supports up to 30 volts RMS input.

Remote In (ACC): Accepts +12V input to turn the amplifier on.

Remote Out: Sends +12V output to trigger additional amplifiers or system components.

H1+	H2+	H3+	H4+	H5+	H6+	H7+	H8+	NC	NC
H1-	H2-	H3-	H4-	H5-	H6-	H7-	H8-	REM OUT	ACC

**6. RCA Output Connector**

Provides a fully DSP-processed audio signal output for connecting external amplifiers, ensuring precise sound tuning and control.

7. RCA Input Connector

One set of RCA inputs for receiving low-level signal from an aftermarket head unit.

8. USB2.0/USB OTG Connector

For firmware updates, DSP tuning, or direct digital audio input via compatible USB devices.

9. Optical Digital Input

Accepts optical digital audio input via compatible cables.

10. TuneLink Connector

Cable that connects two MDSP amplifiers (MDSP10/8A, MDSP8/6A, and MDSP8/4A only) to enable simultaneous tuning of both amplifiers within a single software window.

11. Controller Connector

Interface for an external controller to adjust playback, volume, subwoofer level, switch inputs, or access DSP settings.

12. External Bluetooth Connector

Enables Bluetooth audio streaming or wireless tuning via a mobile app.

Mounting

Exposed Mounting Feet

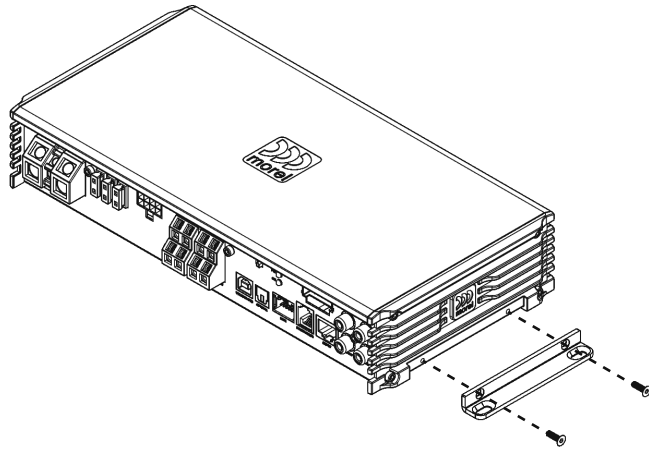

* MDSP10/8A pictured

Discrete Mounting Feet

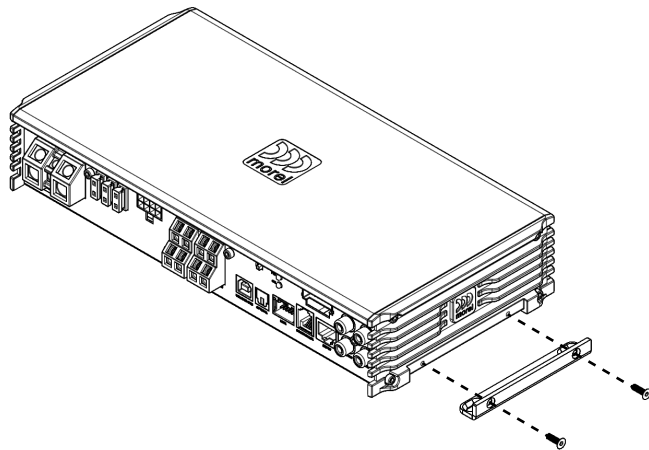

* MDSP10/8A pictured

Discrete Mounting Feet

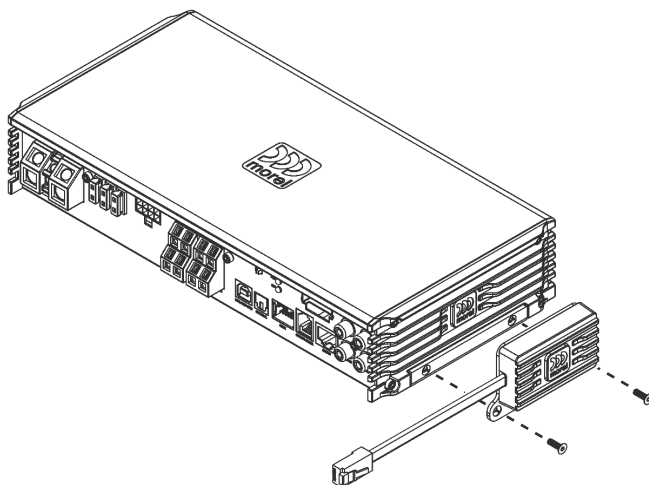

* MDSP10/8A pictured

Power Connections and Fusing

Main Power Connection and Fusing

The MDSP Series amplifiers require 4 AWG wire for both power and ground connections to ensure sufficient current delivery. A fuse must be installed on the power cable within 18 inches (45 cm) of the battery to protect the vehicle and system.

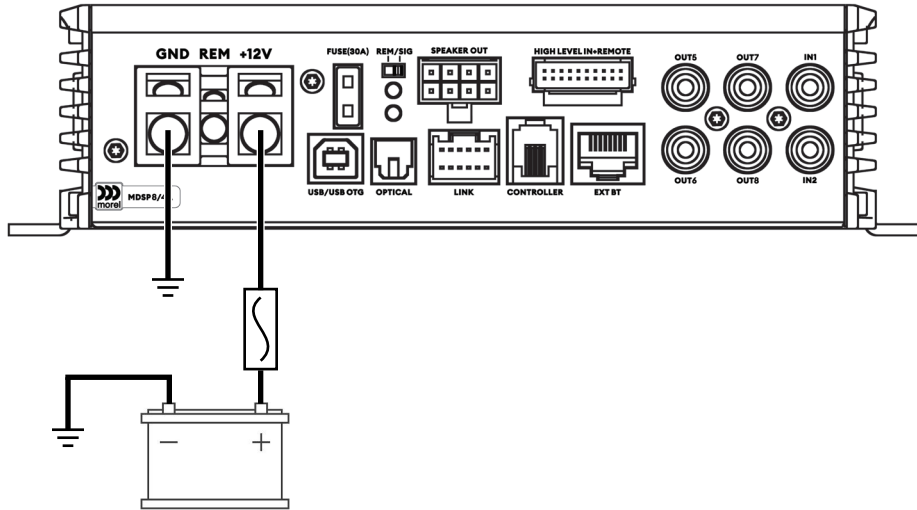

Turning On the MDSP

Remote Turn On

Supplying a +12V signal to the REM IN will turn on the MDSP.

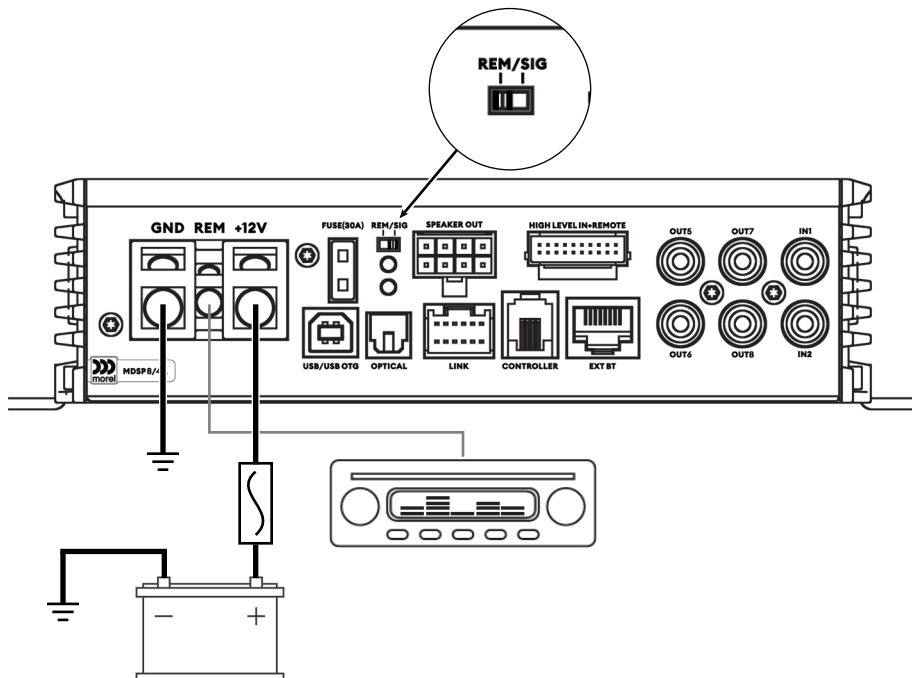

Signal Sensing Turn On

Automatic turn on with BTL signal from High-Level OEM sources.

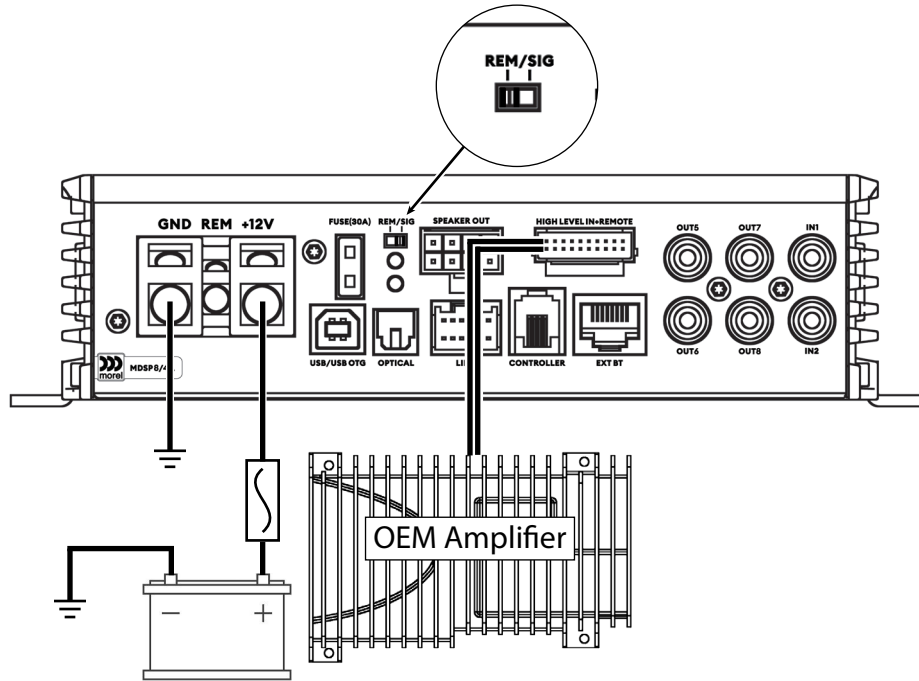

IMPORTANT: SENSE function utilizes High-Level Input #1 (+) and (-) to turn on the MDSP.

Remout Out to Turn on Alternate System Components

REM OUT supplies a switched output that allows for the MDSP to turn on other components in your system. Settings in the MDSP software can alter turn on and turn off timing to better suit your system needs.

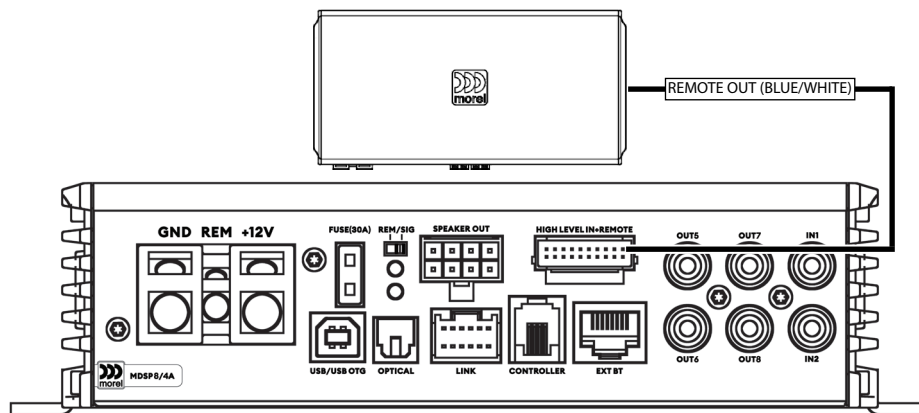

Connecting Signal / Source to MDSP

High-Level / Speaker Level Signal Source

High-level inputs connect OEM audio systems to the MDSP, with SLAM automated load resistors to keep the system active. Channels 1-6 accept up to 16 V, and Channels 7-8 accept up to 30 V.

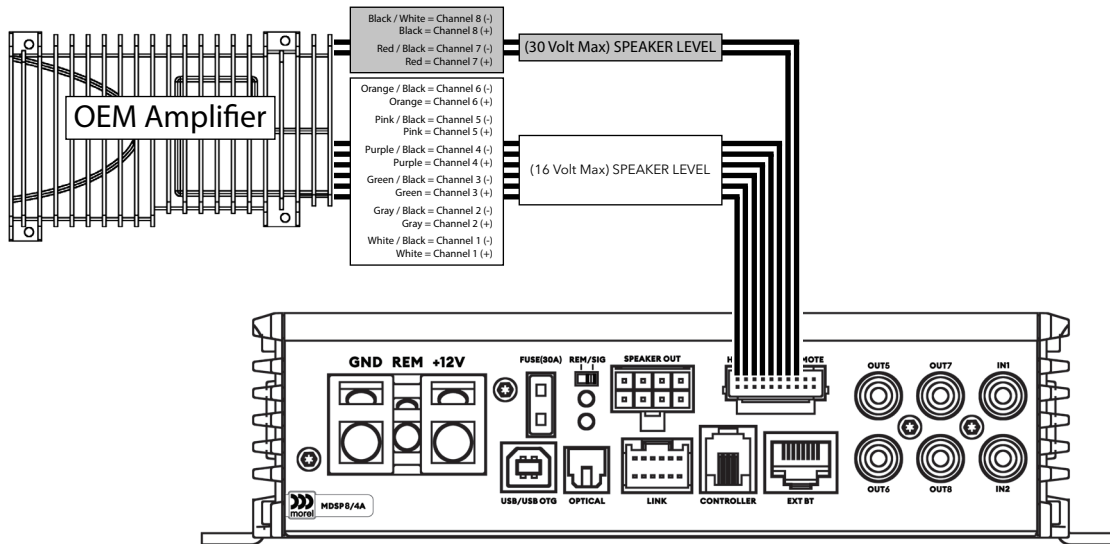

Low-Level / RCA Signal Source

Low-level input utilizes RCA inputs to allow connection to aftermarket source units

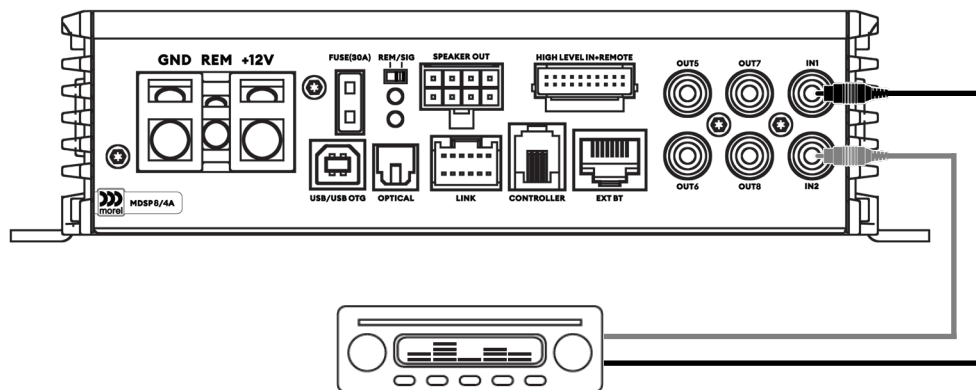

Optical Digital Input

MDSP amplifiers include a TOSLINK optical input for stereo PCM audio up to 96 kHz/24-bit. Connect a compatible source with a TOSLINK cable and enable the input in the Morel MDSP software.

Ways to select the Optical Input:

- DRC Controller - From a DRC AC or DRC MP CAN controller.
- Auto Input Switching - Enable in the Morel MDSP software to switch automatically when a signal is detected.

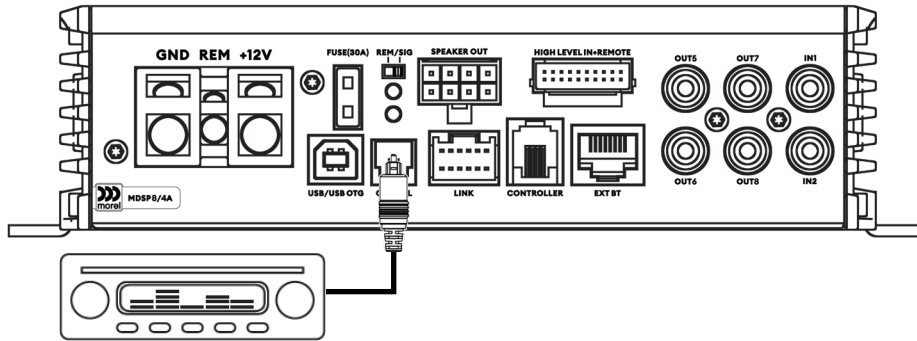

IMPORTANT:

- If your source outputs these formats, switch it to STEREO mode for proper playback.
- Multichannel formats like Dolby Digital (AC3) or DTS are not supported.
- The optical input supports stereo PCM signals only.

OTG Direct Digital Input

MDSP amplifiers feature a USB OTG input for stereo PCM audio up to 96 kHz/24-bit. Connect a compatible device with a USB-B OTG cable and enable the input in the Morel MDSP software.

Ways to select the Optical Input:

- DRC Controller - From a DRC AC or DRC MP CAN controller.
- Auto Input Switching - Enable in the Morel MDSP software to switch automatically when a signal is detected.

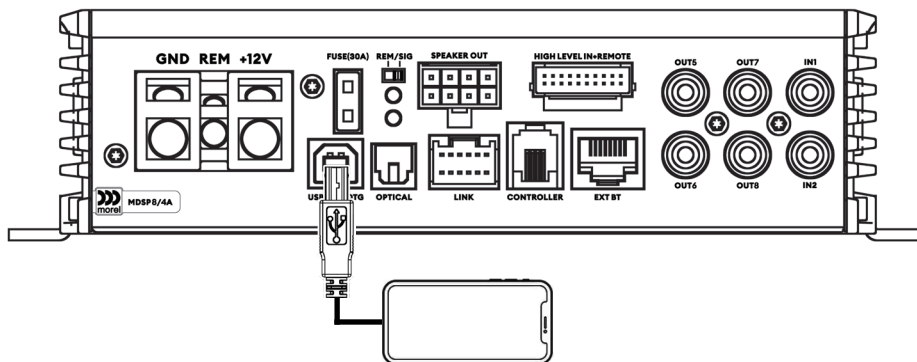

IMPORTANT:

- If your source outputs these formats, switch it to STEREO mode for proper playback.
- Multichannel formats like Dolby Digital (AC3) or DTS are not supported.
- The OTG input supports stereo PCM signals only.

Bluetooth Input

MDSP amplifiers include a TOSLINK optical input for stereo PCM audio up to 96 kHz/24-bit. Connect a compatible source with a TOSLINK cable and enable the input in the Morel MDSP software.

Ways to select the Optical Input:

- DRC Controller - From a DRC AC or DRC MP CAN controller.
- Auto Input Switching - Enable in the Morel MDSP software to switch automatically when a signal is detected.

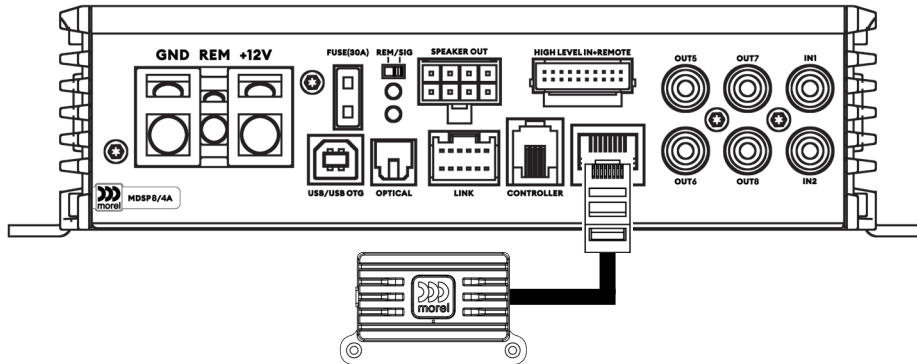

IMPORTANT:

- If your source outputs these formats, switch it to STEREO mode for proper playback.
- Multichannel formats like Dolby Digital (AC3) or DTS are not supported.
- The optical input supports stereo PCM signals only.

Adding Optional DRC (Remote Control)

Remote Controller (DRC)

An optional accessory that provides full user control of the MDSP from the listening position. The DRC allows the user to adjust overall system volume, subwoofer level, source selection, and preset changes, as well as access additional system functions depending on the configuration. This enables quick, convenient adjustments without needing to reach the amplifier or connect to the tuning software, making it ideal for everyday use and fine-tuning during listening.

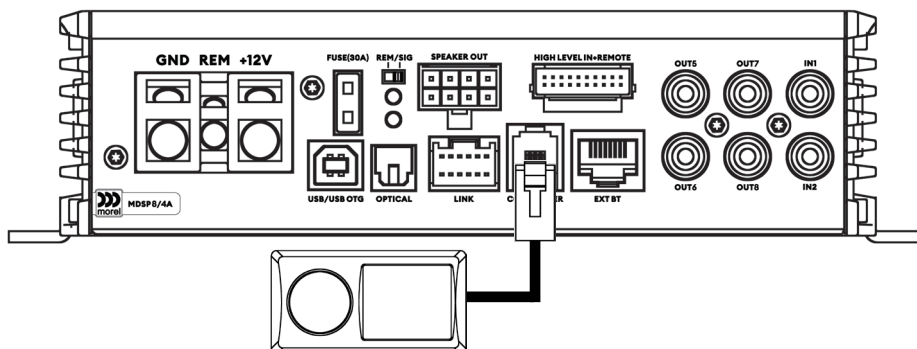

Adding Optional Outboard Aftermarket Amplifier

Remout Out to Turn on Alternate System Components

The MDSP includes four DSP-controlled low-level (RCA) outputs, allowing connection of additional aftermarket amplifiers to expand the system's capabilities.

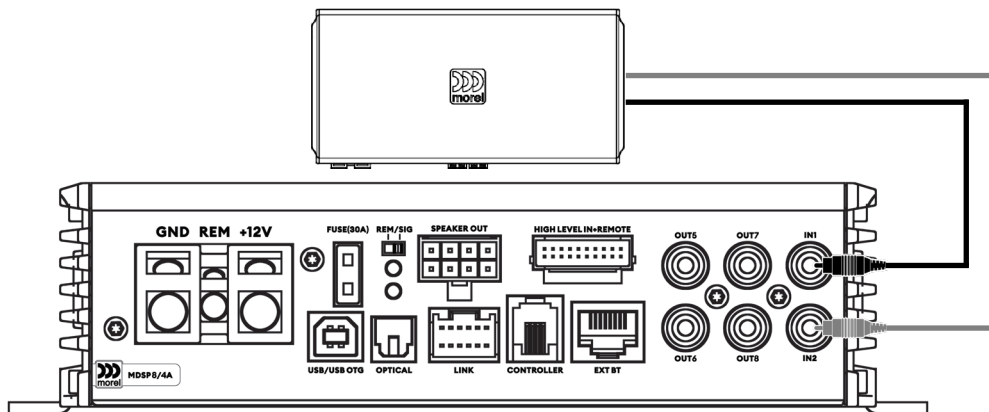

Adding Additional MDSP Amp Via TuneLink

8 Channel System

When adding a second MDSP amplifier, the TuneLink cable links the two units, enabling the software to control both simultaneously. This streamlines the tuning and setup process.

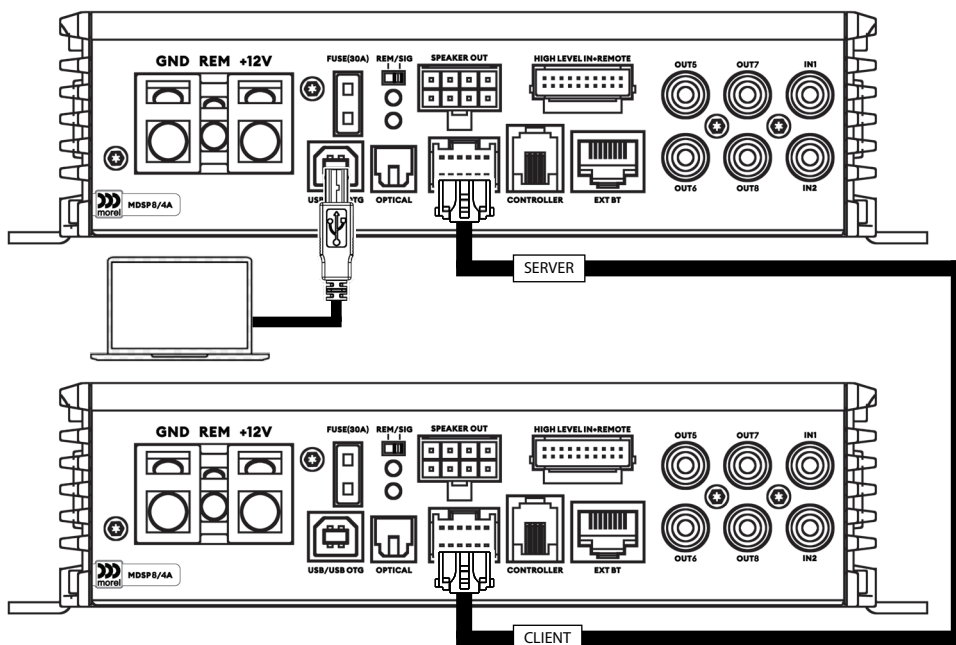

IMPORTANT:

- Only 2 amplifiers total can be connected via TuneLink.
- Additional amplifiers can be connected through the low-level (RCA) output if needed.
- The TuneLink cable is directional, ensure that the cable has the correct orientation or the second amplifier may not be recognized in the software.



Speaker Connections

4 Channel System

The MDSP comes with an 8-pin cable that connects up to four amplified speaker outputs, providing 80 W × 4 at 4Ω.

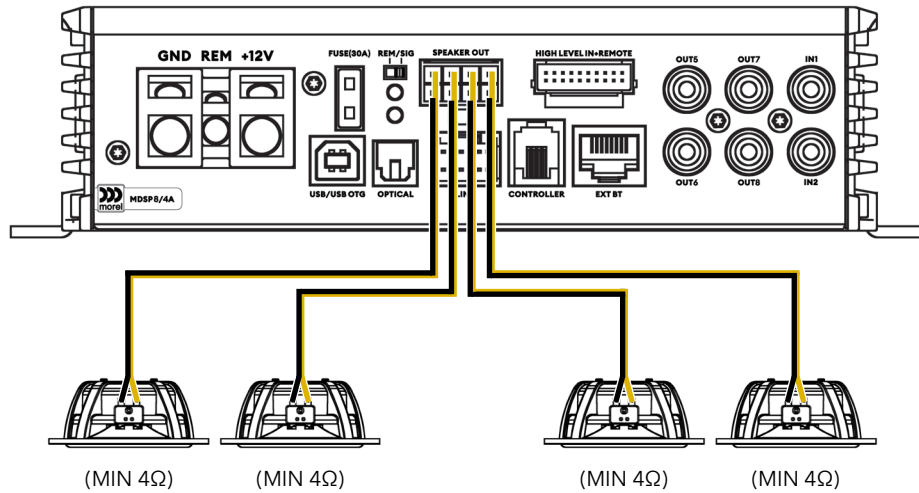

2 Channel System (Bridging)

MDSP amplifiers provide flexible power options. The amplified channels can be bridged to produce up to 150 W RMS at 2Ω, making them well-suited for larger speaker applications.

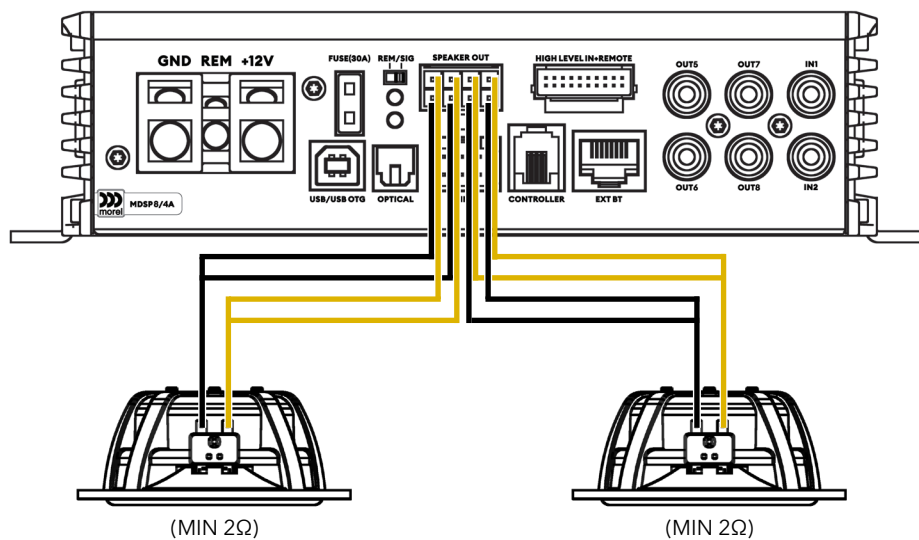

Connection to PC and Software

The MDSP amplifier can be customized with the Morel DSP Software, giving you full control over each of its 10 DSP channels. The software is intuitive and designed to make tuning your system straightforward.

Before You Begin

- Download and install the latest version of Morel DSP Software from www.morelhifi.com
- Regularly check the website for software and firmware updates to ensure your MDSP runs with the latest features and improvements.
- Read the knowledge base for helpful tips and best practices.
- **Important:** Do not connect the amplifier to your computer until the software and USB driver are fully installed.

Connecting Your MDSP

1. Launch the Morel DSP Software on your computer.
2. Connect the MDSP amplifier using the USB cable included in the package.
3. Power on the amplifier. The software will detect it automatically.

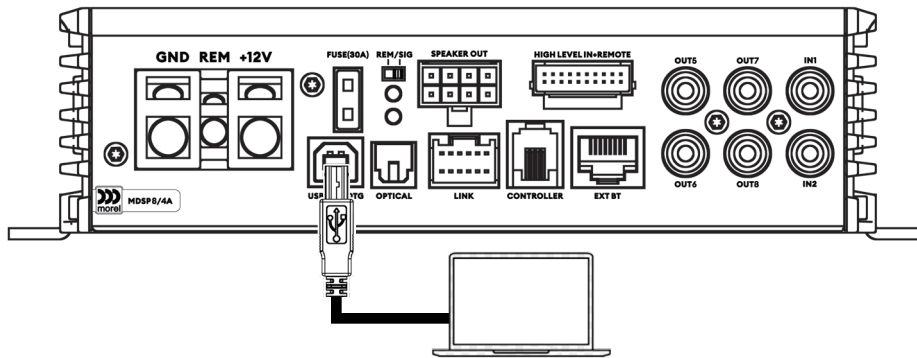

Configuring Your System

- Once connected, you can adjust each DSP channel to your preference.
- Explore the knowledge base for suggested settings and guidance.

Safety Notes

- Keep the car radio volume at minimum during initial setup.
- Avoid connecting any devices to the Line Out until your general settings are configured.
- Incorrect setup, especially in fully active systems, can damage your speakers.



Troubleshooting

Symptom		Possible Casue	Remedy
1.	Amplifier not turning on.	Fuse on main power wire or fuses on the MDSP amplifier have blown.	Replace the failed fuse(s). Failing fuses can indicate that the power and ground are reversed and the install needs to be investigated.
		Wrong turn on option is seleted.	Connect a switched +12v to the REM IN of the power block and select REM on Remote On / Signal Sense Selector Switch.
		Speaker Sense is not seeing a proper signal.	Connect channels 1 & 2 of the High-Level Input Harness to speaker outputs of the OEM audio system.
2.	Power LED is on, but no sound out of the amplifier.	Master Volume is turned down.	On the DRC, in the App, or in the Morel DSP Software, turn up the Master Volume until at desired output. Warning: It is suggested to turn down the source unit to a comfortable level before adjusting Master volume to in case output is set to loud.
		All channels muted.	In the Morel DSP Software, unmute the individual channels or unmute the Master Volume Control.
		The correct source is not selected.	Change the source in the DRC, the Bluetooth App, or in the Morel DSP Software.
		Mixer setting are incorrect.	Make sure that the proper source is being sent to the proper output. If settings are for High-Level and using Low-Level, output will never be able to happen.
		Amplifier is in protect.	Check for illuminated PROTECT light on amplifier. Power cycle the amplifier. If sound continues to shut off, an impedance check should be done on the connected speakers to ensure no shorts are present. Wrong turn on option is selected.
3.	Not getting full-range sound.	Crossovers are not applied correctly.	Make sure that the high-pass and low-pass are not reversed in the settings.
		OEM audio system has crossovers applied to the input signal or the amplifier	The output channels should be verified using an RTA to confirm the frequency response being reproduce.
			If the outputs are crossed over, they must be combined with other channels to achieve a full-range signal. Check the MDSP outputs to determine which channels require additional mixing.



Symptom		Possible Casue	Remedy
4.	Power LED stays on after vehicle turns off.	The MDSP stays on after REM IN or Accessory is turned off.	A delay on turn off is normal. This ensures all components of the system are powered down in the proper order. This turn off delay time can be altered through the Morel DSP Software. If this time was set by an installation shop, the time should likely not be changed or issues may arise.
5.	Distortion of sound in playback.	EQ bands are too high.	Go into the Home, Input, and Global pages to validate no EQ bands are boosted too high. EQ bands should be cut in practice and only boosted if needed and enough headroom is left in the amplifier. Verifying proper headroom can be checked with the CLIPPING INDICATOR on each channel to ensure no harmful signal are present.
6.	Engine whine or engine speed dependent noise is present	RCA's are run next to the main power wire	Isolate the RCA's by moving them to the opposite side of the vehicle or as far away from the power wire as possible (more than 2 feet).
		There is a ground loop issue.	The ground may not have good contact with the chassis of the vehicle. Clean any paint or intrusion between the contact of the ground wire (ring terminal) and the actual metal of the vehicle.
			A ground reference wire needs to be run to connect the ground of the source unit to the amplifier.
			The ground is physically loose. Tighten and check audio.



Specifications

AMPLIFIER

Dynamic Range	≥100dB
S/N (RCA)	≥98dB
T.H.D.	≤0.03%
Frequency Response	20Hz ~ 20kHz
Input Sensitivity	16V / 30V RMS (High-Level) 0.1 - 2V RMS (Low-Level)
Input Impedance	High-Level: 4.7Ω RCA: 10kΩ
Output Impedance (RCA)	51Ω
Load Impedance (MIN)	CH1~CH4: 2Ω
Output Power @ 4Ω	CH1~CH4: 80W (RMS) / 160W (PEAK)
Output Power @ 2Ω	CH1~CH4: 80W (RMS) / 160W (PEAK)
Bridged Output @ 2Ω (PBTL)	CH1~CH4: 2x160W (RMS) / 2x320W (PEAK)

POWER SUPPLY

Voltage (DC)	9~17V
Idle Current	≤0.1W
REM Input	High-Level Start (H1+/H1-) or ACC Start is Optional
REM Output	12V (200mA)
Outboard Fuse (Mini ATC)	30A x 3

OUTPUT

Signal Output (RCA)	2V (RMS)
---------------------	----------



PROCESSOR

System Sampling Rate	96kHz/24bit
Crossover	Full / High-Pass / Low-Pass / Band-Pass
Crossover Type	Bessel / Butterworth / Linkwitz-Riley
Crossover Slope	6 / 12 / 18 / 24 / 30 / 36 / 42 / 48 dB
Crossover Frequency	20Hz~20kHz @ 1Hz Step
Polarity Inversion	0°/180°
Output Equalizer	10-Band Parametric Equalizer ± 12dB per Channel 10-Band Parametric Equalizer ± 12dB Global
Output Equalizer Q Value	0.404 - 28.852
Output Equalizer Resolution	0.1dB per Step
All-Pass Filtering	Input (Per Channel); Output (Per Channel)
Delay Distance	0 - 692 cm; 0 - 273 inch
Delay	0 - 20 ms
Delay Step	0.01 ms
Presets	6

COMPUTER REQUIREMENTS

Operating System	Microsoft Windows (32 / 64 bit) XP, Vista, Windows 7, Windows 8, Windows 10
Graphics (Min)	1024 x 768
PC Connection	USB B (2.0+)

SIZE

Net Weight (kg)	0.41
Dimensions	180mm x 136mm x 50mm

Wishing you many years of sound enjoyment!



Morel, Ness Ziona, 70400 Israel.
Tel: +972-8-9301161
Fax: +972-8-9301312
E-mail: info@morelhifi.com

Morel America, Chandler, AZ, USA
Toll free number: 1-877-667-3511
Fax: 1-718-721-1560
E-mail: info@morelamerica.com

www.morelhifi.com